



PRO-TEK SUPERNOVA2 CHUCK QUICK START INSTRUCTION MANUAL

Thank you for purchasing our PRO-TEK SUPERNOVA2 Chuck – a new premium addition to our Nova woodturning chuck range with advanced features to enhance your chucking performance. It provides a versatile and easy method for fast and secure work holding for all face turning – bowls, egg cup, vases, boxes, goblets and an endless variety of similar projects

YOUR SAFETY

Keep these instructions in a safe place for future reference.

WARNING: This chuck is capable of contributing to serious injury (as with any other power tool accessory) if this manual guidance is not followed or if it is used improperly on the lathe. Read and understand also the lathe owner's manual. If you do not have a manual, contact the supplier of your lathe to obtain one before using the lathe and chuck. User must be professionally trained to use this chuck. Vocational school courses or other expert tuition is recommended.

As with other work holding methods, an extremely cautious and sensible approach is necessary. With the PRO-TEK SUPERNOVA2 Chuck, it is not possible to give exact directions as to the amount of tightening pressure required for adequate work holding or approved chisel cutting techniques. Follow closely strict guidelines in this manual for different jaw types on wood blank diameters and length, plus strictly follow recommended lathe speeds.

Safe Operation:

Eye Protection: Woodturning operations can result in objects being thrown into your eyes which can result in severe eye damage. Protective eye wear must be used at all times. Everyday vision wear is not protective eye wear. We recommend a full-face shield. Always wear eye protection which complies with current ANSI Standard Z87 (USA)

Noise Protection: Use ear plugs or ear defenders. Particularly if the noise exceeds 85dB. Exposure to high levels of noise can lead to hearing problems.

Dust Protection: Use respiratory protective equipment (dust mask, portable respirator device). Exposure to high levels of irritating dust when turning or sanding hardwoods, soft woods and manufactured composite boards (MDF) can result in serious health problems. In addition, adequate workshop dust extraction must be used.

Chuck is properly secured on lathe spindle: Follow mounting instructions for your lathe for faceplates and other spindle fixtures. Do not rotate chuck under power unless workpiece is firmly clamped.

WARNING: LATHE SPEED: Excessive speed is a serious lathe hazard. Always turn at the slowest speed possible. Ideal speed will vary with wood blank size. The larger the blank the slower the speed. Consult your lathe manual or lathe information plate for speed guidelines. Do not attempt to use the chuck unless the recommended lathe speeds to size of wood blank are known. In addition, you must strictly follow the maximum speed limits set out in the operating section of this manual. Do not exceed them under any circumstances.

CHECK WORKPIECE: Examine wood blank carefully before mounting on chuck/lathe. Only mount wood that has no cracks, splits, holes or any other weaknesses (e.g. rotten or spongy sections). Do not use poorly jointed or laminated wood. Irregular or out of balance stock needs to be turned at the slowest possible speed until it is in balance. Make sure wood is clamped firmly. Follow mounting instructions for different gripping modes and jaw types. In the expansion mode do not use undue force or jaws may split the wood.

Do not exceed maximum guidelines in this manual for wood blank diameters/length set out in this manual for different modes and jaw types.

Check wood is securely held in chuck, before operation. Check grip by vigorously wrenching wood blank back and forth. If any loosening occurs, re-examine holding area for adequate grip (Following mounting guidelines) and any damage to holding area. Rotate manually to make sure of clearance before switching power on.

DUPLICATOR OR JIGS: Do not use chuck for work holding with a duplicator or jigs.

Safe Practice:

CHISEL USE: Use only hand held woodturning chisels to shape wood being held in chuck. Use the recommended chisel for the job. Use safe and commonly approved techniques.

WARNING: Never attempt to place hands on a moving chuck on a lathe. Wait for the chuck to come to a complete stop before hands are anywhere near the chuck. Trying to grab at a moving chuck could result in SERIOUS INJURY. Jaw Slides: For safe operation do not extend the jaw slides beyond the chuck body under any circumstances.

Wherever possible stand to one side of the revolving wood.

WEAR SUITABLE CLOTHING: Do not wear any loose clothing, neck ties, gloves, bracelets, rings or other jewellery that could get caught in moving parts. Wear protective hair covering to contain long hair.

DRUGS, ALCOHOL, MEDICATION: Do not operate chuck or lathe while under the influence of drugs, alcohol or any medication.

KEEP CHILDREN AND VISITORS AWAY: All children and visitors should be kept safe distance from the work area.

OPENING AND CLOSING OF JAWS

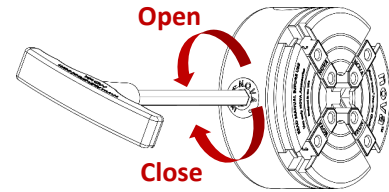

ATTACHING AND REMOVING JAWS

The standard PRO-TEK SUPERNOVA2 Pro-Tek chuck comes included with a set of PRO-TEK 50mm (#6075) add-on jaws.

The jaws must be properly attached on the chuck to function as intended. Before installation, ensure the jaw slide top surfaces are clear of any dust or debris before attaching the jaws on the chuck.

Follow the steps shown below to attach the jaws on the chuck:

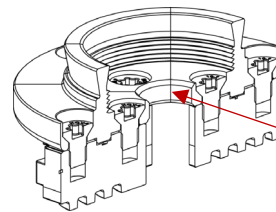

Loosely attach the jaw segments on the jaw slide with the Nova Star head screws included and firmly close the jaws to make sure no light is visible between the jaw segments.

No light visible between jaws

Note: Ensure the number indented on the jaw edge matches the jaw slide number

Firmly tighten the Nova Star head screws by the Nova Star head T-bar handle included.

Loosen and remove the Nova Star screws when removing the jaws from the chuck.

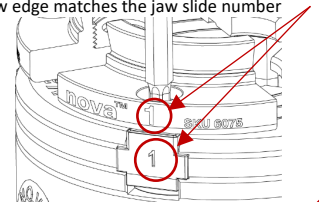

MOUNTING THE SUPERNOVA2 PRO-TEK CHUCK ON THE LATHE

There are two configurations available for the SuperNova2 Pro-Tek chuck:

- Insert model: Requires an insert for chuck to be mounted on the lathe. See full manual online for a list of lathe spindle thread insert available.
- Direct Thread model: M33 RH Eurolock & 1 1/4" 8TPI RH

1. If the chuck is an insert model, ensure the insert is bottomed out on the chuck body before mounting on the lathe.
2. For both Insert & Direct Thread model: Wind the chuck on the lathe spindle until the chuck comes firmly in contact with the bearing/ spindle shoulder with no gaps between.
3. Place the red thread protector washer into the M6 threaded hole. Then wind the M6 grub screw in position and tighten with M3 Allen head wrench (provided) to prevent the chuck from loosening on lathe spindle.

Place red thread protector washer in M6 threaded hole. Then wind in M6 grub screw and tighten.

Make sure there is no gap all around this contact line

Insert bottomed out (if insert model)

*Using the EU M33 Thread locking ring (Only applicable to EU model)

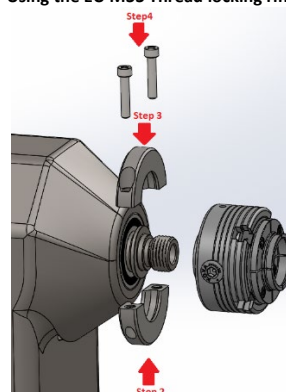

Step 1: Tighten the EU chuck to the spindle on the lathe, make sure the rings on the spindle and chuck have been clamped. (EU Locking Ring provided with lathe)

Step 2: Put the lower part of locking ring under the clamped rings.

Step 3: Put upper part of the locking ring to the clamped rings as well.

Step 4: Using the Allen key to tighten up two bolts on the locking ring.

SCREW CHUCK - WOODWORM SCREW

The woodworm screw (screw chuck) provides a convenient method for holding a bowl blank to cut a recess to mount on the 50mm (2in) jaws.

Jaws must be mounted on the chuck before the wood worm screw – See diagram

Open the jaw slide and insert the wood worm screw in the centre hole of the chuck.

Position the woodworm screw as shown in illustration.

Note: All 4 flat sides of the wood worm screw should be in contact with the flat end of the jaw slides.

Make sure this flat face is coming in contact with the tip of the jaw slide

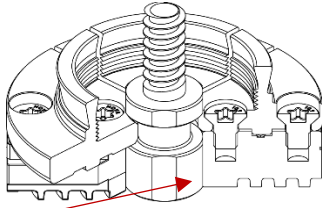

The wood worm screw is used to secure the wood to cut either a recess or spigot on the open 'face' end.

Pre-drill a hole of size 8mm (5/16in) diameter with 19mm (3/4in) depth to mount the blank using the woodworm screw. The wood must be seated firmly and flat against the top surface of the mounted jaws. For first stage rounding of bowl blanks; extra support can be used with live centre support from the lathe tailstock. See full manual online for more details.

DO NOT USE WOOD BLANKS LARGER THAN 250mm DIAMETER X 100mm DEPTH (10inx4in)
DO NOT EXCEED 600RPM

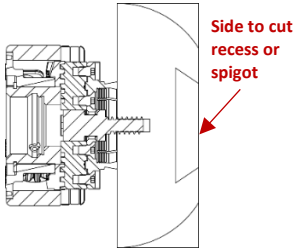

FORMING A SPIGOT OR RECESS



Using a Nova Dovetail Chisel #6008 (or any other suitable tool). Cut into the wood, rest the flat side of the chisel on the bottom surface of the recess to form a profile of between 75°-80deg with 10mm (25/64 in.) depth.

Using a suitable chisel, turn the outer diameter of the wood to form the spigot. The length of the spigot should match the internal height of the jaws.

TURNING A SPIGOT OR DOVETAIL

Spigot is where the jaw contracts onto the workpiece shaped to a cylinder. This is mainly for box, goblet and vase turning (End grain items with a fair degree of overhang).

EXTREME CAUTION WITH THIS OPERATION MUST BE EXERCISED. DO NOT EXCEED 850 RPM FOR THIS OPERATION.

Spigot Diameter (For Pro-Tek 50mm (2in) Jaws)		
	Min Diameter	Max Diameter
Cylinder	45mm (1 3/4in)	65mm (2 9/16in)
Square	40mm (1 9/16in)	50mm (2in)

Dovetail is where the jaw expands into a recess of a workpiece to grip. This operation is mainly for bowls and platters (Items with parallel wood grain).

IT MUST NOT BE USED FOR ANY LONG WORK (OVER 100mm or 4 inches). DO NOT EXCEED 600RPM WITH THIS OPERATION. OUT OF BALANCE STOCK MUST BE TURNED AT THE SLOWEST SPEED POSSIBLE.

Recess Dovetail Diameter (For Pro-Tek 50mm (2") Jaws)	
Min	Max
50mm (2in)	70mm (2 3/4in)

ACCURACY

The PRO-TEK SUPERNOVA2 Chucks are sample tested from each batch and are made to run within the following tolerance limits on the PRO-TEK 50mm (2in) jaws: Maximum Face/Axial Runout: 0.08mm (0.0031 in) - Maximum Radial Runout: 0.15mm (0.0060 in)

However, wood is a flexible material with varying densities and liable to warp while turning. Under these circumstances pursuing accuracies as above, measured on the wood project clamped in the chuck, can be very difficult to achieve. For most wood turning projects there is usually little requirement to achieve such tolerances.

See trouble shooting guide for detailed guide on accuracy in full PRO-TEK SUPERNOVA2 manual online at www.teknaatool.com

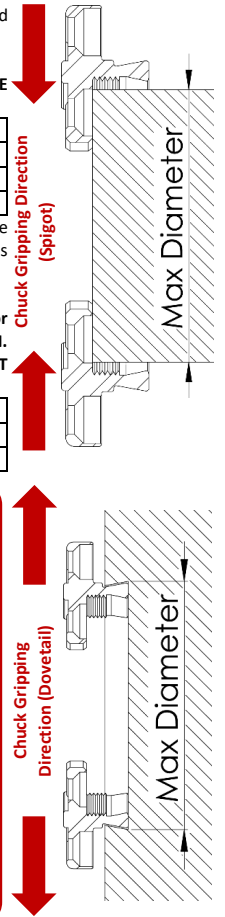

WARRANTY

Your Nova PRO-TEK Chuck is covered by a 6-year Limited Warranty. Go to www.teknaatool.com for a full warranty statement in full version manual PRO-TEK SUPERNOVA2 Chuck. The full online manual also covers trouble shooting, maintenance, list of lathe spindle thread insert adaptors, jaw and chuck accessories.

CONTACT
• Teknaatool International Ltd Phone: (+64) 9 477 5600 • Teknaatool USA Phone: 727-954-3433

CUSTOMER SOLUTIONS
For all worldwide Inquiries, Repairs or Services (issues must be in writing) Email: Service@Teknaatool.com
Or you can contact the retailer where you purchased your NOVA Chuck, for the contact details please see our website www.teknaatool.com



- NEW & IMPROVED FEATURES**
- Rust resistant nickel-plated body for longer protection and less maintenance.
 - Stronger and more versatile PRO-TEK 50mm (2in) Jaws. Dovetail and serrated internal profile for maximum holding power.
 - Right hand, standard clockwise scroll tightening for ease of use.
 - Easier to read, laser etched numbering on edge of PRO-TEK 50mm (2in) jaws
 - Fastener upgrade to Nova Star head jaw screws. No-slip star head for positive T-bar handle location and better tightening power. Star profile to minimize strip out of screw heads.
 - Nova Star head T-bar Handle for easy grip and quicker tightening of screws.
 - Red backing plate for PRO-TEK SUPERNOVA2 Chuck
- Designed and manufactured by Teknaatool International. USA and PRC @ 2020 Teknaatool**
Download the NOVA App!

Chuck is compatible with all nova jaws including the jaws shown above.
Note: Excluding jaws that are specific for Nova Titan chucks

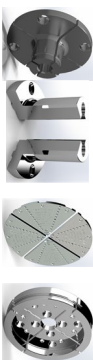

Optional Accessory Jaws



NOVA™

PRO-TEK SUPERNOVA2 CHUCK

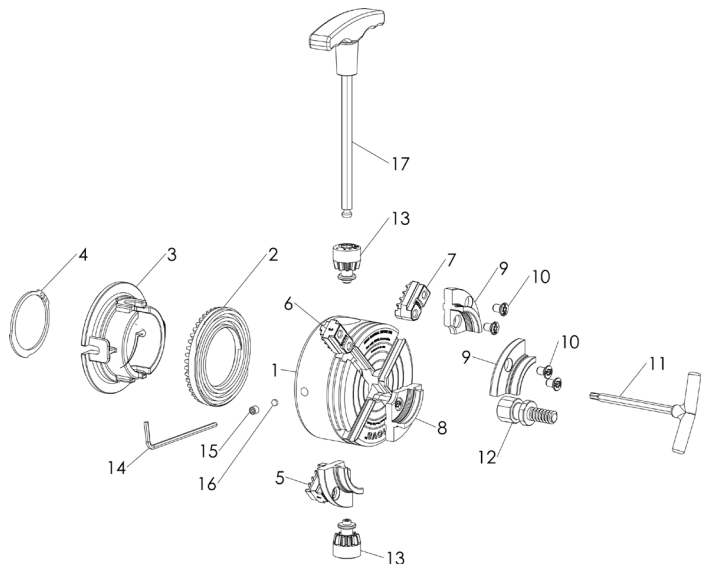

REF#	QTY.	PART#	DESCRIPTION	REF#	QTY.	PART#	DESCRIPTION
1	1	1319011	Supernova2 Pro-Tek Body EU	9	1	6075	Pro-Tek 50mm (2in) Jaws
		23049	Supernova2 Pro-Tek Body	10	8	CM5010182	Nova Star head Screw C/Sunk
2	1	23109	Scroll Ring Right Hand	11	1	13049	Nova Star head T-Handle
3	1	23048	Plastic Backing Plate	12	1	10006	Wood Screw
4	1	EC48, EC50	Circlip	13	2	23110	Pinion Right Hand
5	1	23103	Jaw Slide 1 with stop Pin EU	14	1	AK3	Allen Key 3mm
		23051	Jaw Slide 1	15	1	G0606	Grub screw
6	1	23052	Jaw Slide 2	16	2	NS1000	Fibre Washer
7	1	23053	Jaw Slide 3	17	1	13006	T-Bar Chuck key
8	1	23054	Jaw Slide 4				